



Power Module

AEP820B08TFST

DATASHEET

V1.2, 2022/12

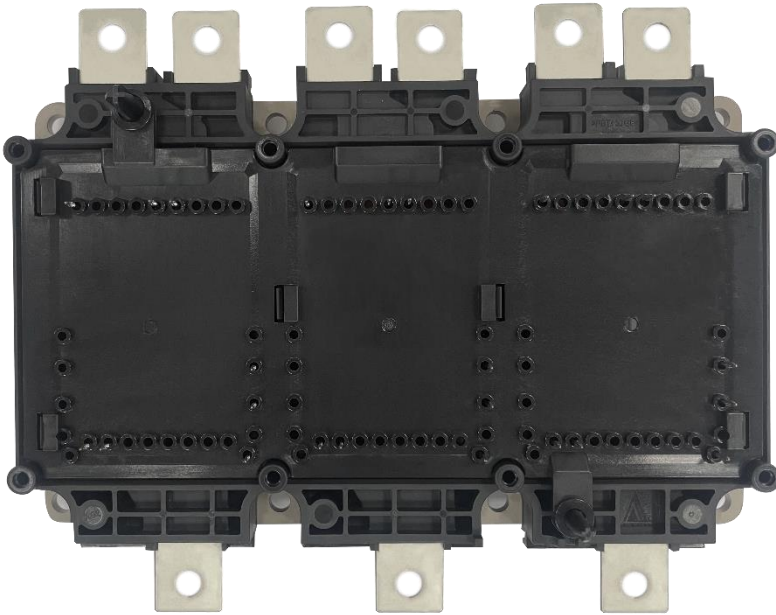

Applications

- Motor Drives
- All-Terrain Vehicles
- Automotive Applications
- Hybrid Electrical Vehicles (H) EV
- Commercial Agriculture Vehicles

Electrical Features

- Low Q_g
- $T_{j,op} = 150^{\circ}\text{C}$
- Low Inductive Design
- Blocking voltage 750V
- Fast and soft reverse recovery
- Low V_{CEsat} and Switching Losses

Mechanical Features

- Compact design
- 4.2KV DC Insulation
- UL 94 V0 Module frame
- Temperature sense included
- Direct Water Cooling Base Plate
- Easy to Integrate 6-pack Topology
- Pb-free device and RoHS compliant
- Guiding elements for PCB and cooler assembly

FEATURES

- High speed, low loss IGBT module
- High reliability, high durability module

Circuit Diagram

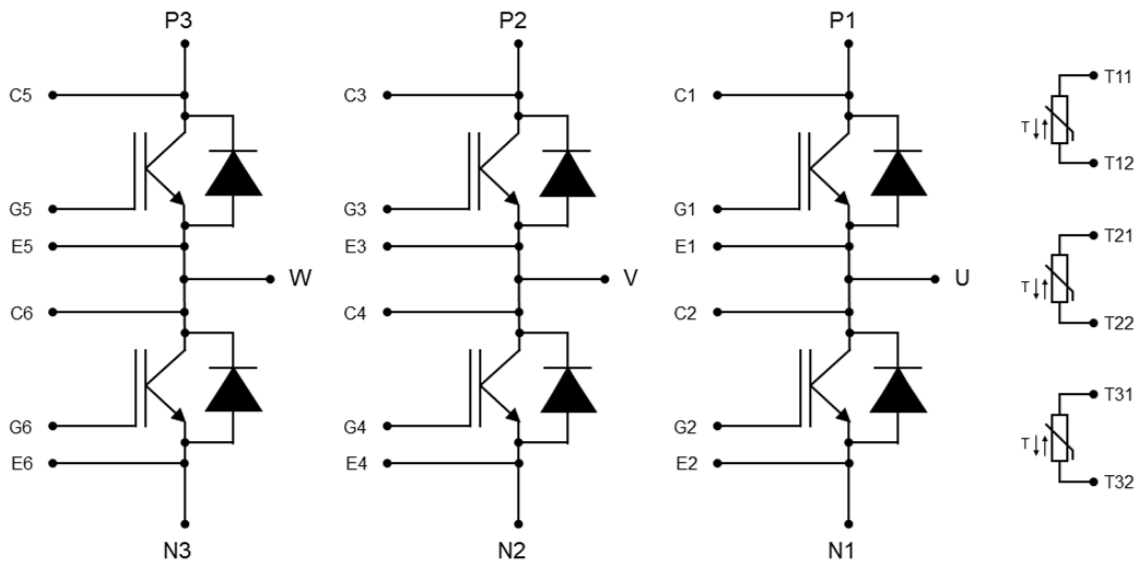



IGBT Inverter

Maximum Rated Values

Parameter	Conditions	Symbol	Values	Unit
Collector-emitter voltage	$T_j = 25^\circ\text{C}$	V_{CES}	750	V
Gate-emitter peak voltage		V_{GES}	± 20	V
Implemented collector current		I_{CN}	820	A
Continuous DC collector current	$T_F = 70^\circ\text{C}, T_j = 175^\circ\text{C}$	$I_{C\ nom}$	450	A
Repetitive peak collector current	$t_p = 1\ \text{ms}$	I_{CRM}	1640	A
Maximum Junction Temperature		$T_{j,max}$	175	$^\circ\text{C}$

Characteristics Values

Parameter	Conditions	Symbol	Min.	Typ.	Max.	Unit	
Collector-emitter saturation voltage	$I_C = 450\text{A}, V_{GE} = 15\text{V}$	$V_{CE,sat}$			$T_j = 25^\circ\text{C}$	1.15	V
	$I_C = 450\text{A}, V_{GE} = 15\text{V}$				$T_j = 150^\circ\text{C}$	1.25	
	$I_C = 450\text{A}, V_{GE} = 15\text{V}$				$T_j = 175^\circ\text{C}$	1.30	
	$I_C = 820\text{A}, V_{GE} = 15\text{V}$				$T_j = 25^\circ\text{C}$	1.40	
	$I_C = 820\text{A}, V_{GE} = 15\text{V}$				$T_j = 150^\circ\text{C}$	1.60	
	$I_C = 820\text{A}, V_{GE} = 15\text{V}$				$T_j = 175^\circ\text{C}$	1.70	
Gate threshold voltage	$I_C = 9.6\ \text{mA}, V_{CE} = V_{GE}$	V_{Geth}		5.10	$T_j = 25^\circ\text{C}$	5.70	V
	$I_C = 9.6\ \text{mA}, V_{CE} = V_{GE}$				$T_j = 150^\circ\text{C}$	4.20	
	$I_C = 9.6\ \text{mA}, V_{CE} = V_{GE}$				$T_j = 175^\circ\text{C}$	3.95	
Collector-emitter cut-off current	$V_{CE} = 750\text{V}, V_{GE} = 0\text{V}$	I_{CES}			$T_j = 25^\circ\text{C}$	1.0	mA
	$V_{CE} = 750\text{V}, V_{GE} = 0\text{V}$				$T_j = 150^\circ\text{C}$	5.0	
	$V_{CE} = 750\text{V}, V_{GE} = 0\text{V}$				$T_j = 175^\circ\text{C}$	10.0	
Gate-emitter leakage current	$V_{CE} = 0\text{V}, V_{GE} = 20\text{V}$	I_{GES}				400	nA
Gate Charge	$V_{GE} = -8\ \text{V} / +15\ \text{V},$ $V_{CE} = 400\text{V}$	Q_g				2.2	μC
Internal gate resistor		R_{Gint}				1.7	Ω
Input capacitance	$f = 1\text{MHz}, V_{CE} = 50\ \text{V},$ $V_{GE} = 0\text{V}$	C_{ies}				45	nF
Output capacitance	$f = 1\text{MHz}, V_{CE} = 50\ \text{V},$ $V_{GE} = 0\text{V}$	C_{oes}				2.8	nF
Reverse transfer capacitance	$f = 1\text{MHz}, V_{CE} = 50\ \text{V},$ $V_{GE} = 0\text{V}$	C_{res}				1.5	nF



AEP820B08TFST Power Module

ACTRON TECHNOLOGY CORP.

Parameter	Conditions	Symbol	Min.	Typ.	Max.	Unit
Turn-on delay time, inductive load	$I_C = 450A, V_{CE} = 400V,$ $V_{GE} = -8V / +15V$ $R_{GON} = 2.5\ \Omega$	$T_j = 25^\circ C$ $T_j = 150^\circ C$ $T_j = 175^\circ C$	$t_{d(on)}$	0.14 0.11 0.11		μs
Rise time, inductive load	$I_C = 450A, V_{CE} = 400V,$ $V_{GE} = -8V / +15V$ $R_{GON} = 2.5\ \Omega$	$T_j = 25^\circ C$ $T_j = 150^\circ C$ $T_j = 175^\circ C$	t_r	0.069 0.070 0.072		μs
Turn-on energy loss per pulse	$I_C = 450A, V_{CE} = 400V,$ $L_S = 30nH$ $V_{GE} = -8V / +15V,$ $R_{GON} = 2.5\ \Omega$ $di/dt = 5500\ A/\mu s (25^\circ C)$ $di/dt = 5100\ A/\mu s (150^\circ C)$	$T_j = 25^\circ C$ $T_j = 150^\circ C$ $T_j = 175^\circ C$	E_{on}	13.5 15.5 17.5		mJ
Turn-off delay time, inductive load	$I_C = 450A, V_{CE} = 400V,$ $V_{GE} = -8V / +15V$ $R_{Goff} = 5.0\ \Omega$	$T_j = 25^\circ C$ $T_j = 150^\circ C$ $T_j = 175^\circ C$	$t_{d(off)}$	0.55 0.56 0.57		μs
Fall time, inductive load	$I_C = 450A, V_{CE} = 400V,$ $V_{GE} = -8V / +15V$ $R_{Goff} = 5.0\ \Omega$	$T_j = 25^\circ C$ $T_j = 150^\circ C$ $T_j = 175^\circ C$	t_f	0.27 0.42 0.45		μs
Turn-off energy loss per pulse	$I_C = 450A, V_{CE} = 400V,$ $L_S = 30nH$ $V_{GE} = -8V / +15V,$ $R_{Goff} = 5.0\ \Omega$ $dv/dt = 2500\ V/\mu s (25^\circ C)$ $dv/dt = 2200\ V/\mu s (150^\circ C)$	$T_j = 25^\circ C$ $T_j = 150^\circ C$ $T_j = 175^\circ C$	E_{off}	35.5 45.5 50.5		mJ
SC data	$V_{GE} \leq 15V, V_{CC} = 400V$ $t_p \leq 6\ \mu s$ $t_p \leq 3\ \mu s$	$T_j = 25^\circ C$ $T_j = 175^\circ C$	I_{sc}	4800 3800		A
Thermal resistance, junction to cooling fluid	Per IGBT; $dV/dT = 10\ dm^3/min,$ $T_F = 70^\circ C$		R_{thJF}	0.120	0.140	K/W



Diode Inverter

Maximum Rated Values

Parameter	Conditions	Symbol	Values	Unit
Repetitive peak reverse voltage	$T_j = 25^\circ\text{C}$	V_{RRM}	750	V
Implemented forward current		I_{FN}	820	A
Continuous DC forward current		I_F	450	A
Repetitive peak forward current	$t_p = 1 \text{ ms}$	I_{FRM}	1640	A
I^2t (value)	$V_R = 0 \text{ V}$, $t_p = 10 \text{ ms}$, $T_j = 150^\circ\text{C}$	I^2t	19000	A^2s

Characteristics Values

Parameter	Conditions	Symbol	Typ.	Max.	Unit	
Forward voltage	$I_F = 450\text{A}$, $V_{GE} = 0\text{V}$	V_F	$T_j = 25^\circ\text{C}$	1.45	1.65	V
	$I_F = 450\text{A}$, $V_{GE} = 0\text{V}$		$T_j = 150^\circ\text{C}$	1.50		
	$I_F = 450\text{A}$, $V_{GE} = 0\text{V}$		$T_j = 175^\circ\text{C}$	1.55		
	$I_F = 820\text{A}$, $V_{GE} = 0\text{V}$		$T_j = 25^\circ\text{C}$	1.80		
	$I_F = 820\text{A}$, $V_{GE} = 0\text{V}$		$T_j = 150^\circ\text{C}$	1.85		
	$I_F = 820\text{A}$, $V_{GE} = 0\text{V}$		$T_j = 175^\circ\text{C}$	1.90		
Peak reverse recovery current	$I_F = 450\text{A}$, $V_R = 400\text{V}$, $V_{GE} = -8\text{V}$, $-di_F/dt = 5000 \text{ A}/\mu\text{s}$ (25°C) $-di_F/dt = 4100 \text{ A}/\mu\text{s}$ (150°C)	I_{RM}	$T_j = 25^\circ\text{C}$	225	A	
			$T_j = 150^\circ\text{C}$	275		
			$T_j = 175^\circ\text{C}$	290		
Recovered charge	$I_F = 450\text{A}$, $V_R = 400\text{V}$, $V_{GE} = -8\text{V}$, $-di_F/dt = 5000 \text{ A}/\mu\text{s}$ (25°C) $-di_F/dt = 4100 \text{ A}/\mu\text{s}$ (150°C)	Q_{rr}	$T_j = 25^\circ\text{C}$	14.0	μC	
			$T_j = 150^\circ\text{C}$	26.5		
			$T_j = 175^\circ\text{C}$	31.0		
Reverse recovery energy	$I_F = 450\text{A}$, $V_R = 400\text{V}$, $V_{GE} = -8\text{V}$, $-di_F/dt = 5000 \text{ A}/\mu\text{s}$ (25°C) $-di_F/dt = 4100 \text{ A}/\mu\text{s}$ (150°C)	E_{rec}	$T_j = 25^\circ\text{C}$	3.5	mJ	
			$T_j = 150^\circ\text{C}$	8.3		
			$T_j = 175^\circ\text{C}$	9.6		
Thermal resistance, junction to cooling fluid	Per diode; $dV/dT = 10 \text{ dm}^3/\text{min}$, $T_F = 70^\circ\text{C}$	R_{thJF}	0.175	0.200	K/W	



NTC-Thermistor

Parameter	Conditions	Symbol	Min.	Typ.	Max.	Unit
Rated resistance	$T_c = 25^\circ\text{C}$	R_{25}		5.0		k Ω
Resistance tolerance	$T_c = 100^\circ\text{C}$, $R_{100}=493\Omega$	$\Delta R/R$	5		5	%
B-value	$R_2 = R_{25} \exp [B_{25/50}(1/T_2 - 1/(298 \text{ K}))]$	$B_{25/50}$		3375		K
B-value	$R_2 = R_{25} \exp [B_{25/80}(1/T_2 - 1/(298 \text{ K}))]$	$B_{25/80}$		3411		K
B-value	$R_2 = R_{25} \exp [B_{25/100}(1/T_2 - 1/(298 \text{ K}))]$	$B_{25/100}$		3433		K

Module

Parameter	Conditions	Symbol	Value	Unit
Isolation test voltage	RMS, $f = 0 \text{ Hz}$, $t = 1 \text{ sec}$	V_{ISOL}	4.2	kV
Module baseplate material			Cu + Ni	
Module internal isolation material			Al_2O_3	
Creepage distance	Terminal to Heat sink	d_{cree}	9.0	mm
	Terminal to Terminal		9.0	
Clearance	Terminal to heat sink	d_{clear}	4.5	mm
	Terminal to Terminal		4.5	
Comparative tracking index ¹⁾		CTI	> 200	

Parameter	Conditions	Symbol	Min.	Typ.	Max.	Unit
Module stray inductance		L_{SCE}		7		nH
Storage temperature		T_{stg}	-40		125	$^\circ\text{C}$
Weight		G		750		g

¹⁾ Extracted by following UL 746A

Characteristics Diagrams

Output characteristics IGBT, Inverter
 $V_{GE} = 15\text{ V}$, $I_C = f(V_{CE})$

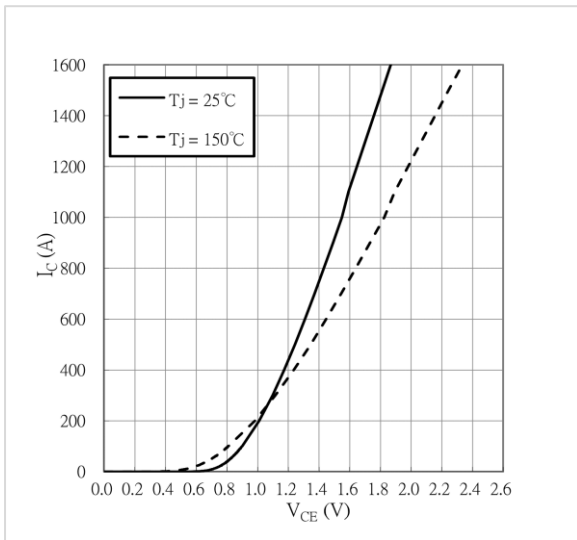

Output characteristics IGBT, Inverter
 $T_j = 25^\circ\text{C}$, $I_C = f(V_{CE})$

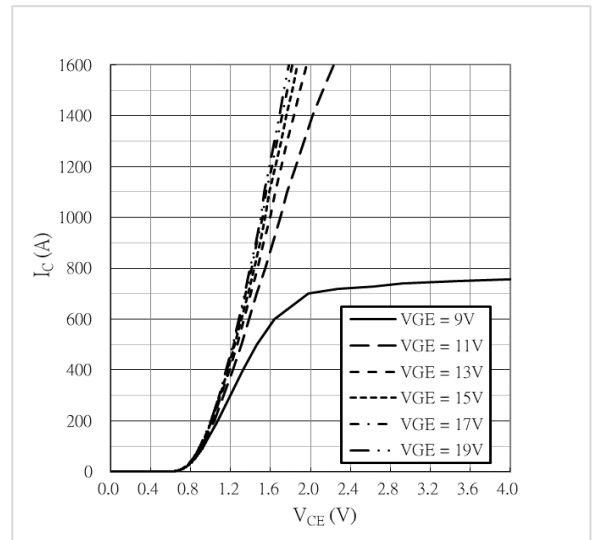

Output characteristics IGBT, Inverter
 $T_j = 150^\circ\text{C}$, $I_C = f(V_{CE})$

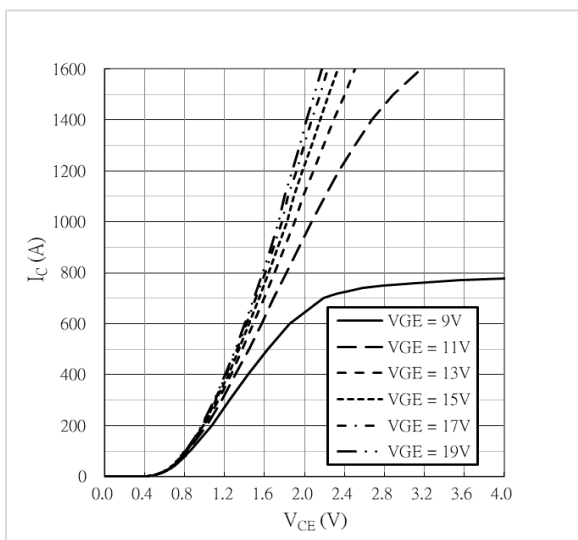

Forward characteristics of Diode, Inverter
 $I_f = f(V_f)$

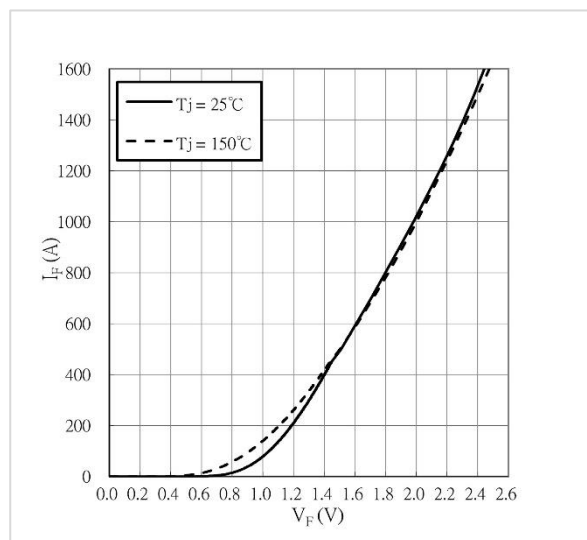



AEP820B08TFST Power Module

ACTRON TECHNOLOGY CORP.

Switching losses IGBT, Inverter

$V_{GE} = +15\text{ V} / -8\text{ V}$, $R_{GON} = 2.5\ \Omega$,

$R_{Goff} = 5.0\ \Omega$, $V_{CE} = 400\text{ V}$, $E_{ON} \& E_{off} = f(I_C)$

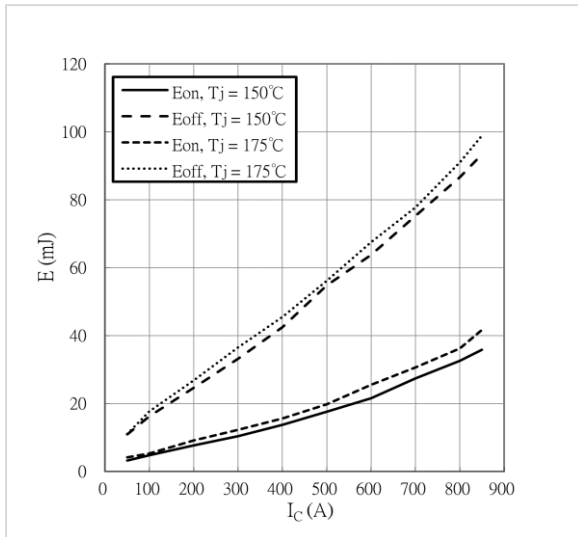

Capacitance characteristics IGBT, inverter

$V_{GE} = 0\text{ V}$, $T_j = 25^\circ\text{C}$, $f = 1\text{ MHz}$, $C = f(V_{CE})$

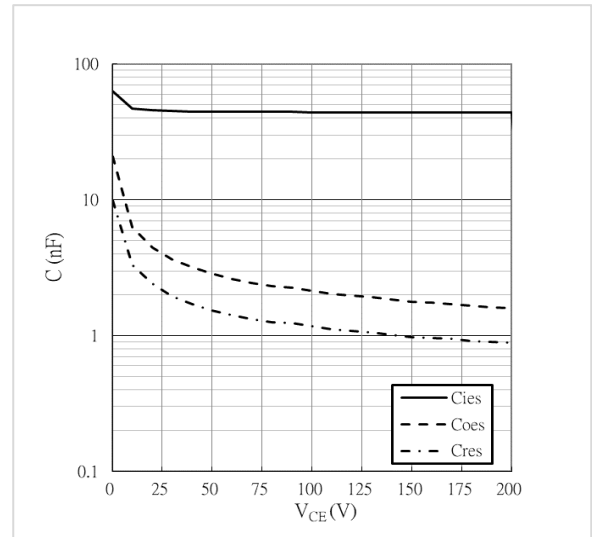

Switching losses IGBT, Inverter

$V_{GE} = +15\text{ V} / -8\text{ V}$, $V_{CE} = 400\text{ V}$, $I_C = 450\text{ A}$

$E_{ON} \& E_{off} = f(R_g)$

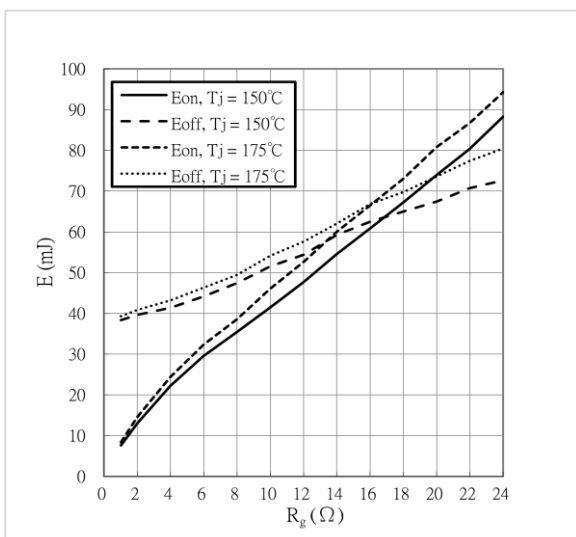

NTC-Thermistor-temperature characteristic

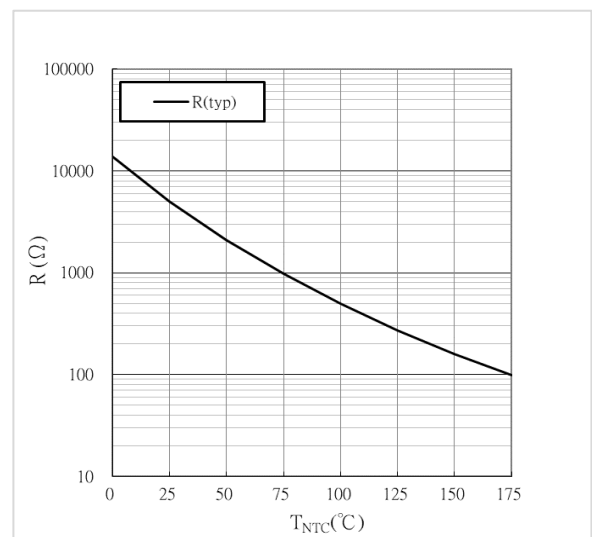

Switching losses Diode, Inverter
 $R_G = 2.5 \Omega$, $V_R = 400 \text{ V}$, $E_{rec} = f(I_f)$

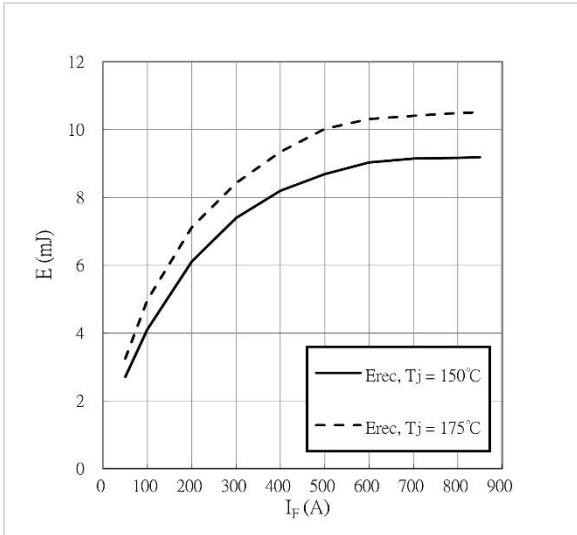

Reverse bias safe operating area (RBSOA)
 $V_{GE} = +15 \text{ V} / -8 \text{ V}$, $R_{Goff} = 5.0 \Omega$, $T_j = 175^\circ\text{C}$

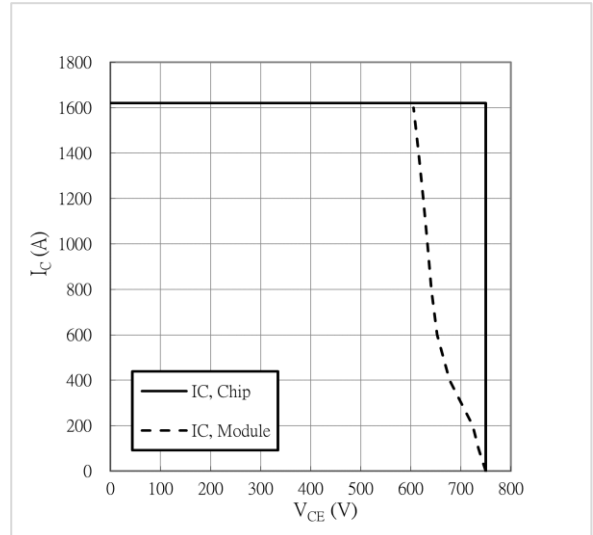

Switching losses Diode, Inverter
 $I_F = 450 \text{ A}$, $V_R = 400 \text{ V}$, $E_{rec} = f(R_g)$

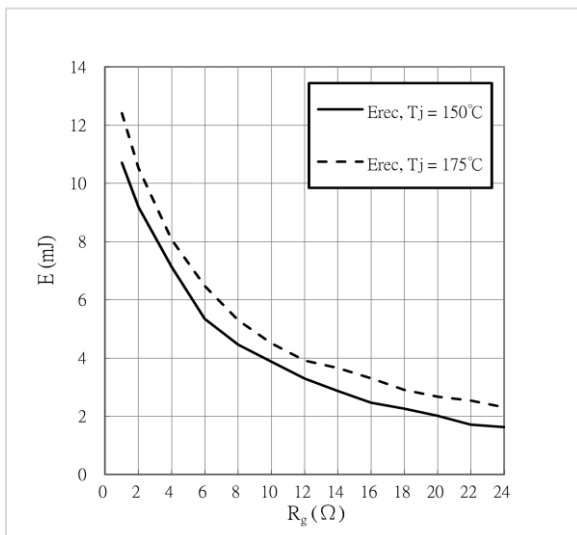



ACTRON TECHNOLOGY CORP.

AEP820B08TFST Power Module

Package Outlines

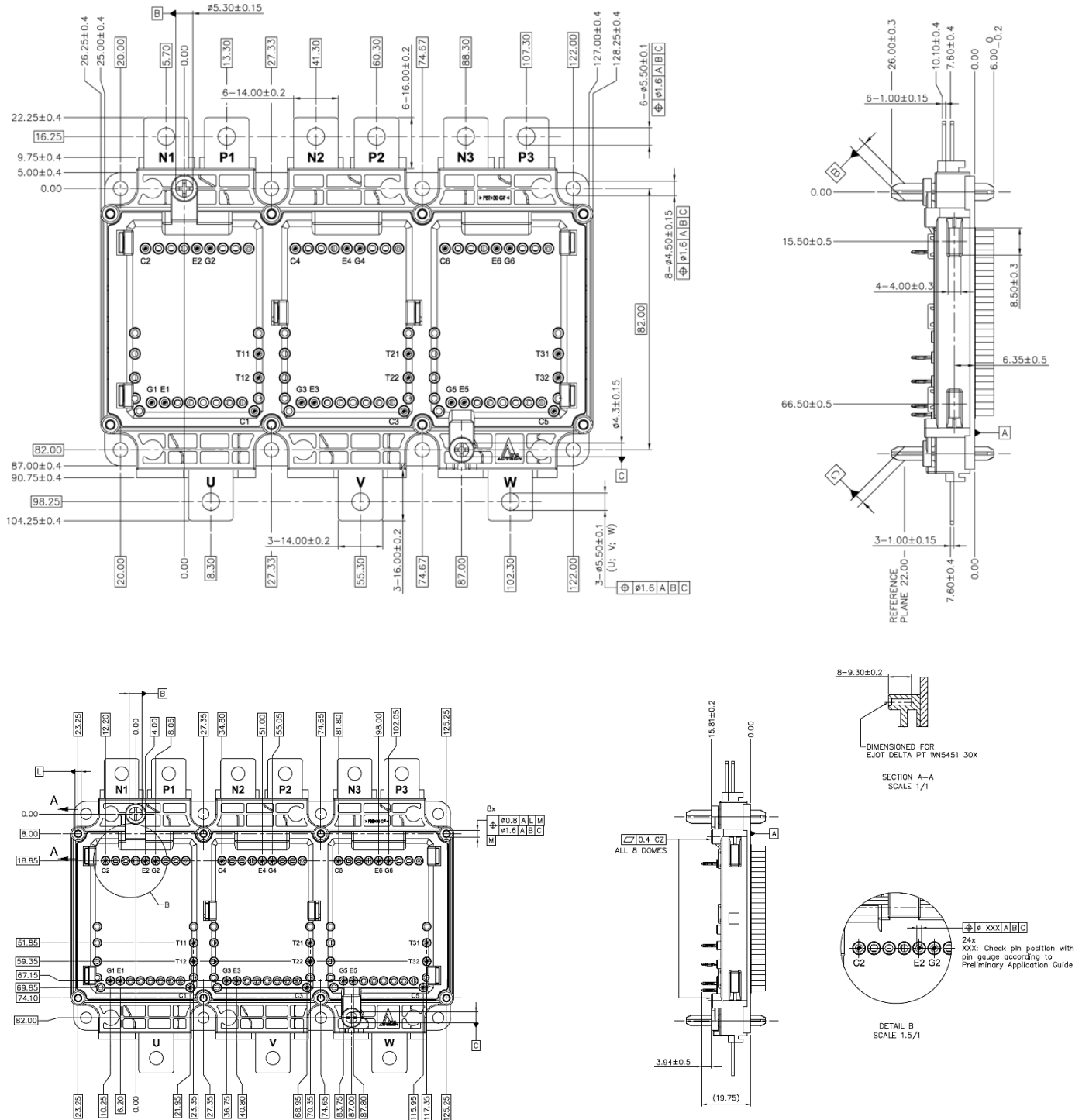

IMPORTANT NOTICE AND DISCLAIMER

Edition 2022-12

**Published by
Actron Technology**

The information given in this document shall declare not to be regarded as a guarantee of conditions or characteristics. With respect to any examples or hints given herein, any typical values stated herein and / or any information regarding the application of the device. Actron technology provides such information, and other resources “as is”, and disclaims all warranties, express and implied, including without limitation any implied warranties of merchantability, fitness for a particular purpose or non-infringement of third party intellectual property rights.

These resources are intended for skilled developers designing with Actron products. You are solely responsible for (1) selecting the appropriate Actron products for your application, (2) designing, validating and testing your application, and (3) ensuring your application meets applicable standards, and any other safety, security, regulatory or other requirements.

For further information on technology, delivery terms and conditions and prices, please contact the Actron Technology. (<http://www.actron.com.tw/>)

Warnings Due to technical requirements, components may contain dangerous substances. For information on the types in question, please contact the Actron Technology. Actron Technology components may be used in special applications only with the express written approval of Actron Technology.



Trademarks of Actron Technology
Copyright © 2022 Actron Technology — All Rights Reserved.

